

INSTALLATION INSTRUCTIONS

Polaris RZRXP Rear Bumper

Item	Description	Qty
A	Rear Bumper, Top	1
B	Lower Elbow, Left	1
C	Lower Elbow, Right	1

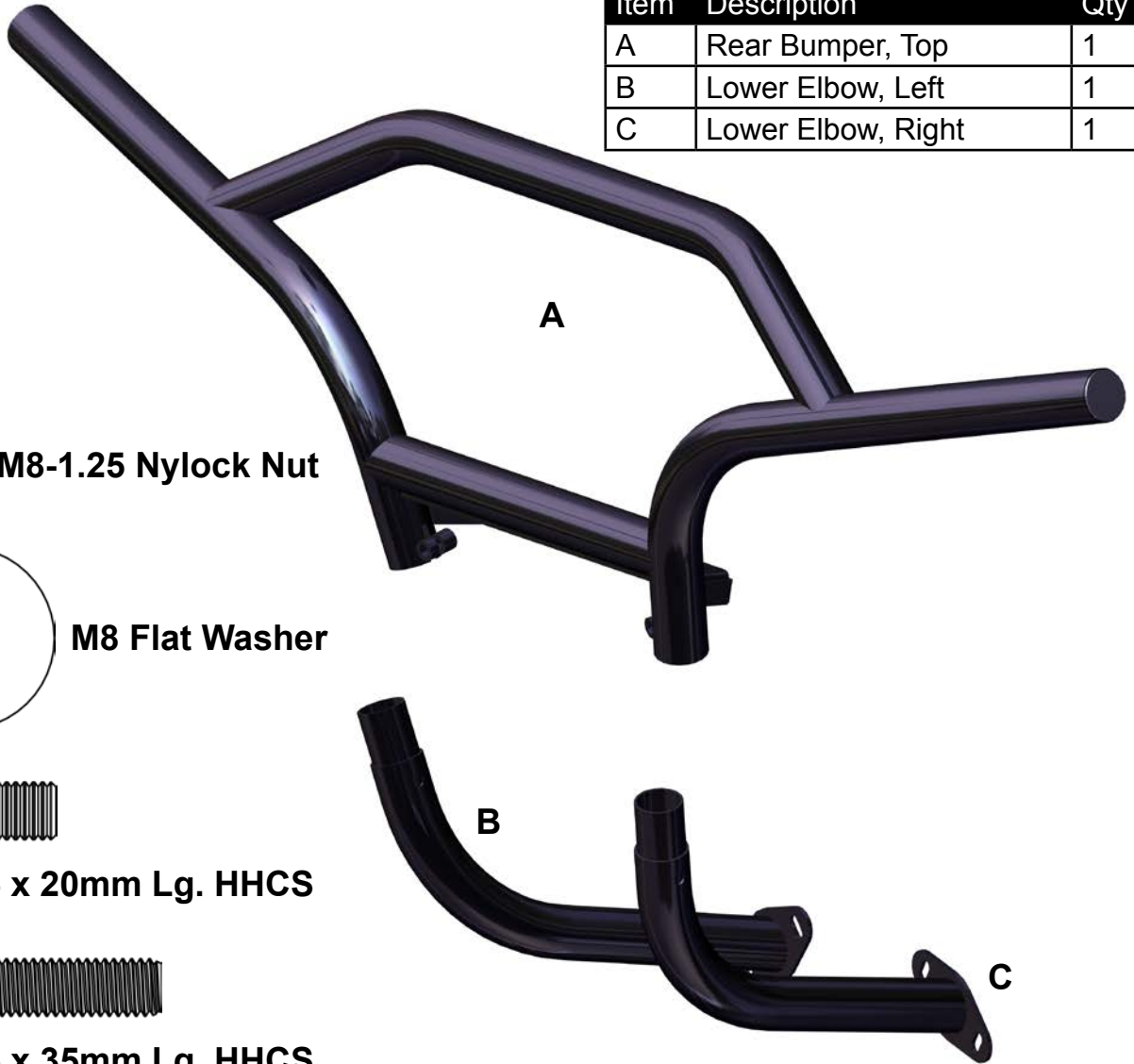

Qty (6)  M8-1.25 Nylock Nut

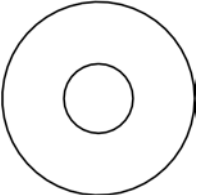
Qty (6)  M8 Flat Washer

Qty (6)  M8-1.25 x 20mm Lg. HHCS

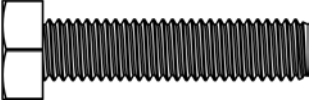
Qty (2)  M8-1.25 x 35mm Lg. HHCS

Read instructions and view illustrations before beginning.

Need help with your installation?



sales@superatv.com



www.superatv.com



1-812-574-7777



8:00am - 9:00pm EST M-Th
8:00am - 7:00pm EST Friday
9:00am - 2:00pm EST Saturday

*Thank You
For Choosing*



Liability Statement

SuperATV's products are designed to best fit users ATV/UTV under stock conditions. Adding, modifying, or fabricating any factory, or aftermarket, parts will void any warranty provided by SuperATV and is not recommended. SuperATV's products could interfere with other aftermarket accessories. If user has aftermarket products on machine, contact SuperATV to verify that they will work together.

Although SuperATV has thousands of satisfied customers, user should be aware that installing lift kits, long travel, or suspension kits, tires, etc will change the ride of machine and may increase maintenance and part wear. Operating any off-road machine while, or after, consuming alcohol and/or drugs increases risk of bodily harm or death. No warranty or representation is made as to this product's ability to protect user from severe injury or death. SuperATV urges operators and occupants to wear a helmet and appropriate riding gear at all times.

By purchasing and installing SuperATV products, user agrees that should damages occur, SuperATV will not be held responsible for loss of time, use, labor fees, replacement parts, or freight charges. SuperATV, nor any 3rd party, will not be held responsible for any direct, indirect, incidental, special, or consequential damages that result from any product purchased from SuperATV. The total liability of seller to user for all damages, losses, and causes of action, if any, shall not exceed the total purchase price paid for the product that gave rise to the claim.

SuperATV will warranty only parts provided by SuperATV. Any damage or problems with OEM housings, bearings, seals, or other manufacturers products will not be covered by SuperATV. SuperATV parts and products are not warrantied if item was not installed properly, misused, or modified.



Installed

Do not tighten hardware completely unless noted.

1. Locate (4) holes for mounting Lower Elbows (C)(B). See Fig. 1.
2. Install Lower Elbows (C)(B) with M8-1.25 x 20mm Lg. HHCS and M8-1.25 Nylock Nuts. See Fig. 2.
3. Join Rear Bumper, Top (A) and Lower Elbows (C)(B) with M8-1.25 x 35mm Lg. HHCS. See Fig. 3.
4. Place Rear Bumper, Top (A) onto Lower Elbows (C)(B) and secure to frame with M8-1.25 x 20mm Lg. HHCS, M8 Flat Washers, and M8-1.25 Nylock Nuts. See Fig. 3.
5. Align bumper assembly to machine and tighten hardware completely.

(illustrations on following pages)

Fig. 1

Lower Elbow Mounting Locations

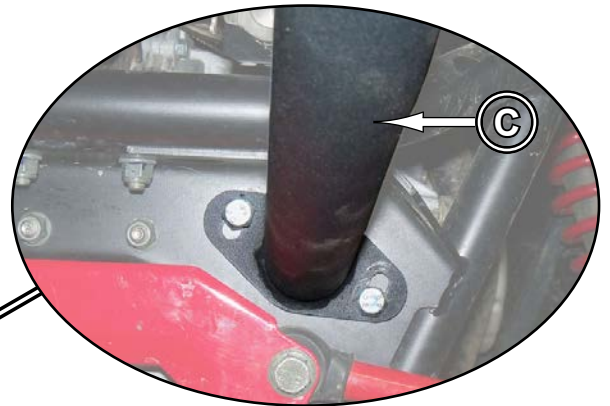
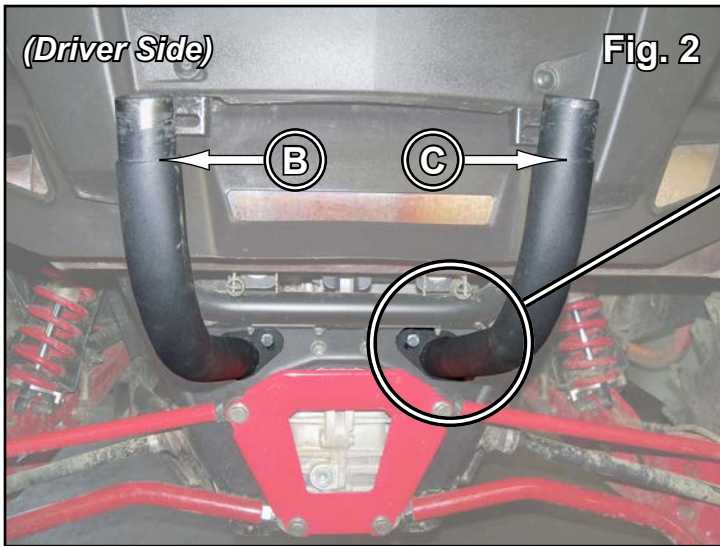

Qty (4)

M8 x 20mm Lg. HHCS

Qty (4)

M8 Nylock Nut

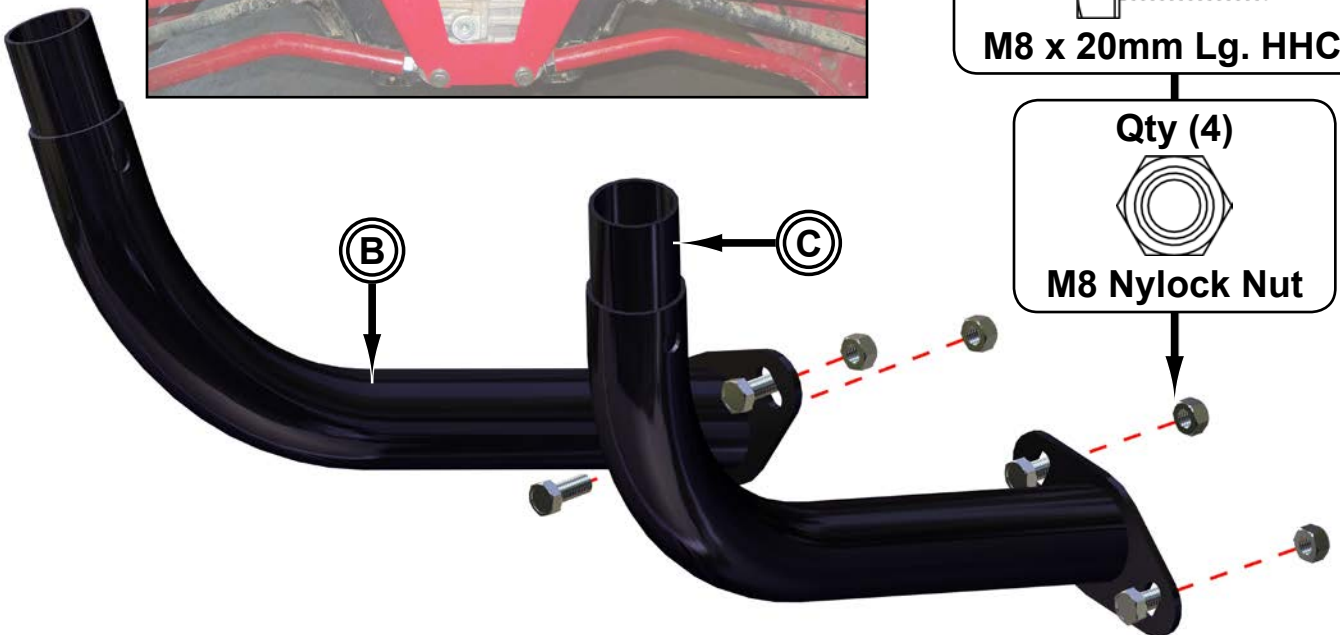

Fig. 3

