

Item	Description	Qty
A	Motor Mount	1
B	ECU Mount	1
C	Support Bracket	1
D	Lower Shaft	1
E	Upper Shaft	1
J	Wiring Connectors Kit	1

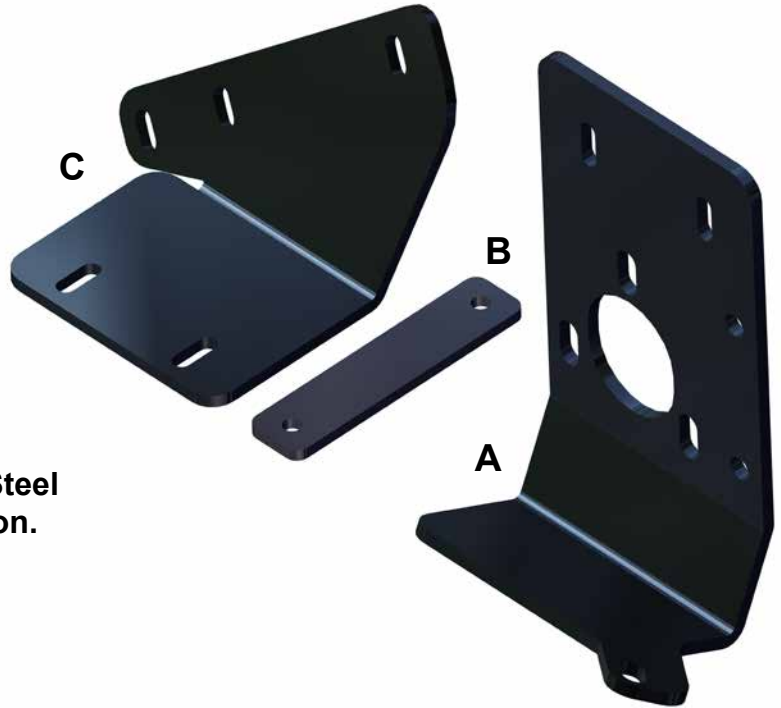

If kit includes (2) Plastic Bushings and/or a Steel Spacer, discard. Not used for this application.

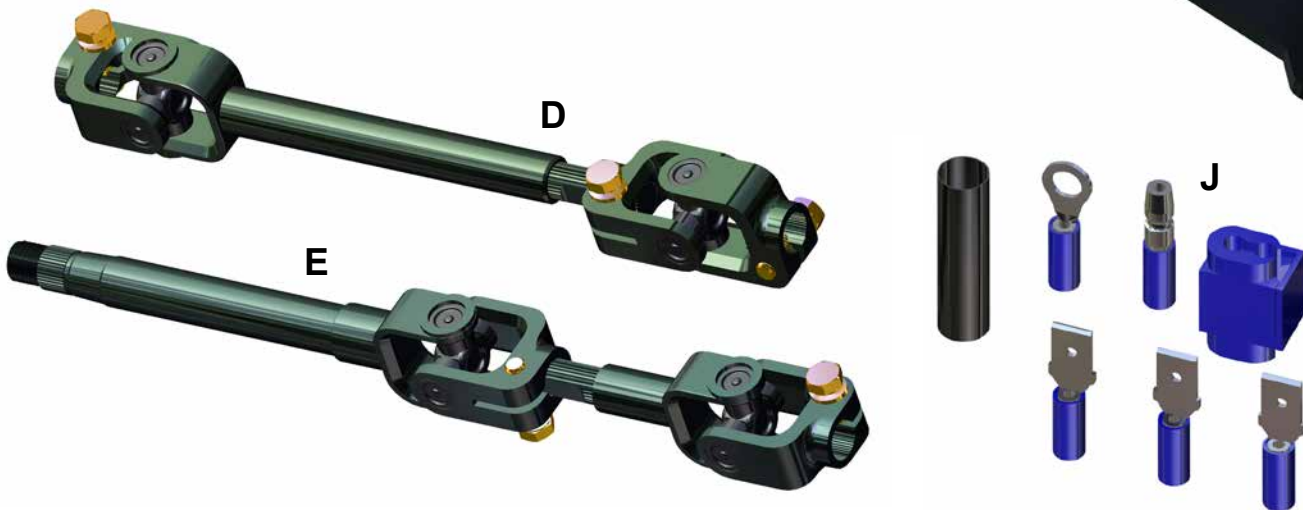

(kit contents continue on following page)

Read instructions and view illustrations before beginning.

Need help with your installation?



sales@superatv.com



www.superatv.com



1-812-574-7777



8:00am - 9:00pm EST M-Th
8:00am - 7:00pm EST Friday
9:00am - 2:00pm EST Saturday

Thank You
For Choosing



Liability Statement

SuperATV's products are designed to best fit users ATV/UTV under stock conditions. Adding, modifying, or fabricating any factory, or aftermarket, parts will void any warranty provided by SuperATV and is not recommended. SuperATV's products could interfere with other aftermarket accessories. If user has aftermarket products on machine, contact SuperATV to verify that they will work together.

Although SuperATV has thousands of satisfied customers, user should be aware that installing lift kits, long travel, or suspension kits, tires, etc will change the ride of machine and may increase maintenance and part wear. Operating any off-road machine while, or after, consuming alcohol and/or drugs increases risk of bodily harm or death. No warranty or representation is made as to this product's ability to protect user from severe injury or death. SuperATV urges operators and occupants to wear a helmet and appropriate riding gear at all times.

By purchasing and installing SuperATV products, user agrees that should damages occur, SuperATV will not be held responsible for loss of time, use, labor fees, replacement parts, or freight charges. SuperATV, nor any 3rd party, will not be held responsible for any direct, indirect, incidental, special, or consequential damages that result from any product purchased from SuperATV. The total liability of seller to user for all damages, losses, and causes of action, if any, shall not exceed the total purchase price paid for the product that gave rise to the claim.

SuperATV will warranty only parts provided by SuperATV. Any damage or problems with OEM housings, bearings, seals, or other manufacturers products will not be covered by SuperATV. SuperATV parts and products are not warranted if item was not installed properly, misused, or modified.



Item	Description	Qty
F	ECU	1
G	Motor	1
H	Wire Harness	1



Qty (5)  M6 x 20mm Lg. FHCS

Qty (3)  M8 x 20mm Lg. FHCS

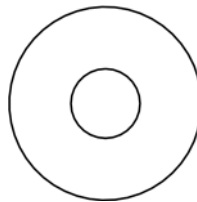
Qty (1)  M8 Flat Washer

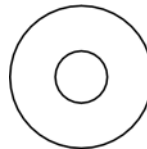

Qty (5)  M6 Flat Washer

Qty (5)  M6 Nylock Nuts

Removal: *Keep all components removed from machine.*

1. Remove Steering Shaft Bolt on Steering Rack. See Fig. 1.
2. Remove Steering Wheel and Shaft. *Hint: Removing Steering Column Bolt may ease removal.* See Fig. 2.

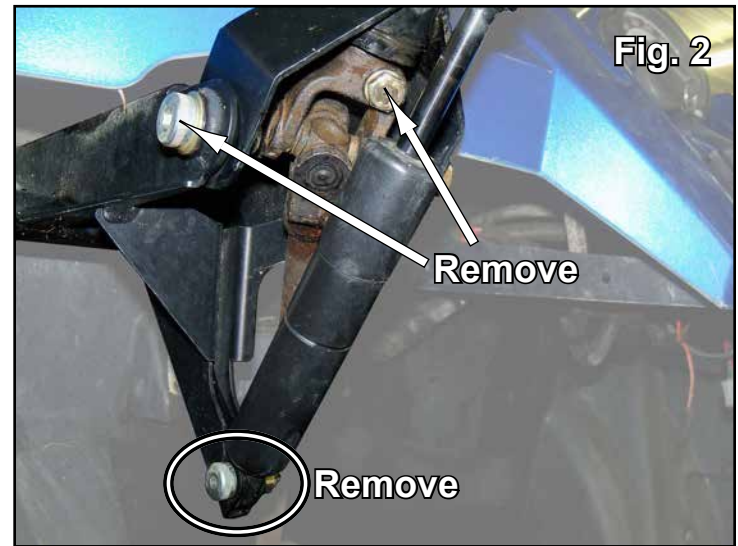
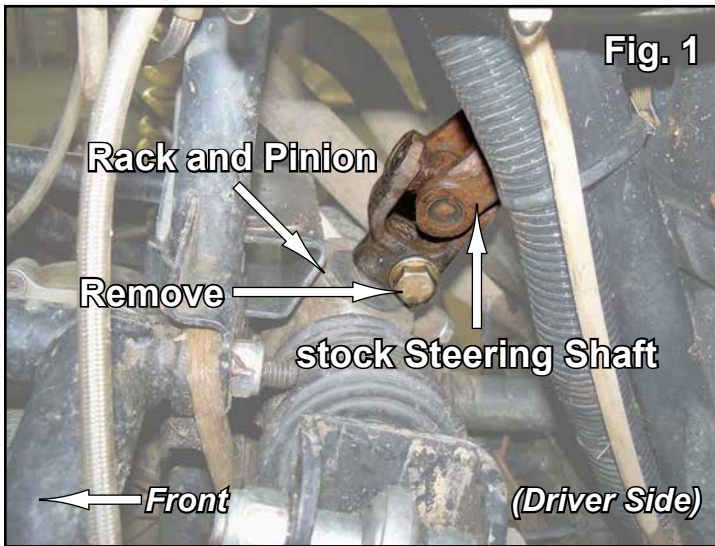

Installation: *Do not tighten hardware completely unless noted.*

1. Install Lower Shaft (D) to Steering Rack with provided hardware. See Figs. 3 - 3a. Tighten completely.
2. Install Motor (G) to Lower Shaft (D) with provided hardware. See Motor Shafts Detail and Fig. 4.
3. Join Mounting Brackets (A)(C) with M6-1.0 x 20mm Lg. FHCS, M6 Flat Washers, and M6-1.0 Nylock Nuts. See Fig. 5.
 - Install to Motor (G) with M8-1.25 x 20mm Lg. FHCS. See Fig. 5.
4. Install Tab on Mounting Bracket (A) to Steering Column with stock hardware and M8 Flat Washer. See Figs. 6a - 6b.
5. Attach Upper Shaft (E) to Motor (G), tighten completely, and reinstall Steering Wheel; reuse stock Washers and Spacers. See Fig. 6a.
6. Locate (2) holes in Steering Frame underneath Dash. See Fig. 6.
 - Secure Mounting Bracket (C) with M6-1.0 x 20mm Lg. FHCS, M6 Flat Washers, and M6-1.0 Nylock Nuts. See Figs. 6a - 6b.

-See "Connections" portion of instructions before installing ECU-

7. Install ECU (F) and ECU Mount (B) to Frame with M6-1.0 x 20mm Lg. FHCS. See Figs. 8 - 8b. Plug in Wire Harness (H). See Connections and Wiring Details.
8. Tighten all hardware completely.

(illustrations continue on following pages)

When joining Shafts, scalloped area must be positioned so that Bolt cleanly engages

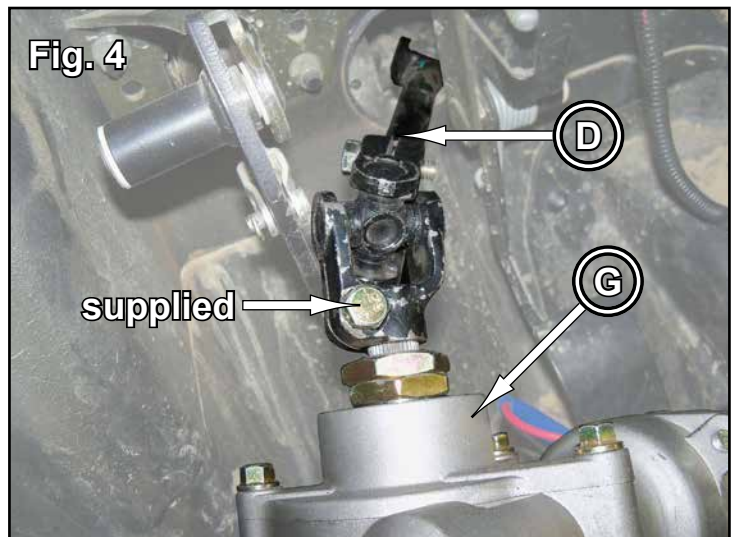
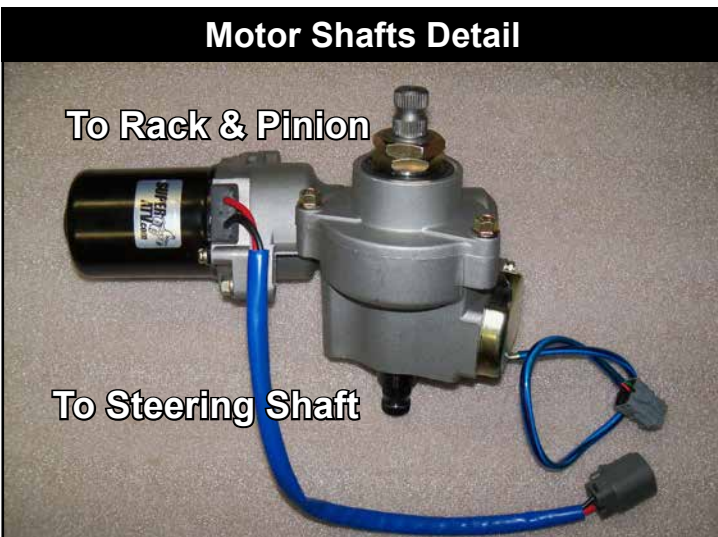
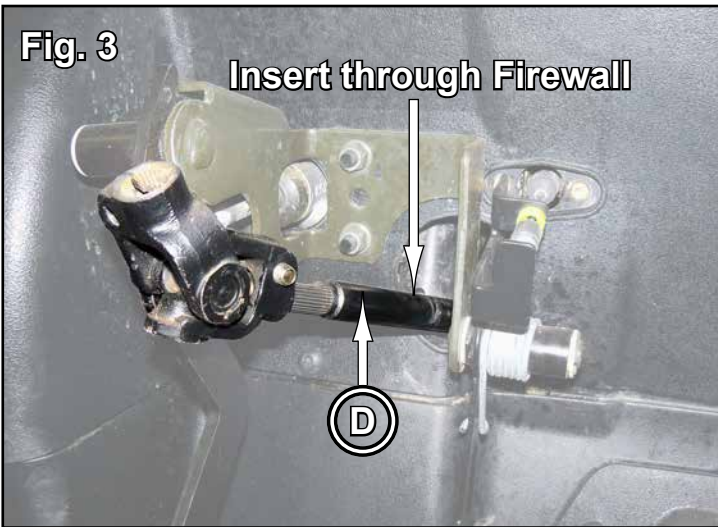
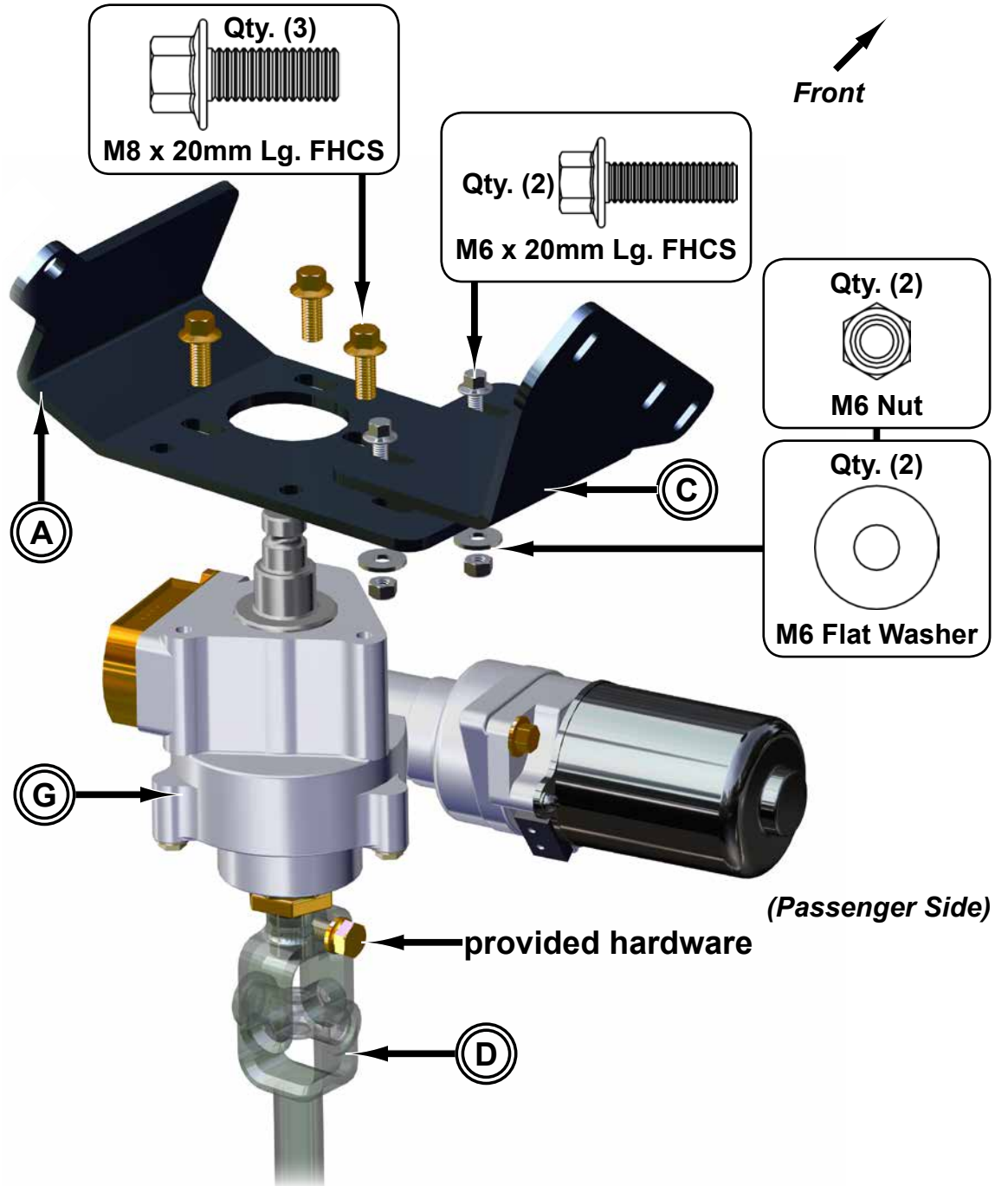

Fig. 5

(Driver Side)



Reuse stock Washers and Spacers when reinstalling Steering Wheel.

Fig. 6a

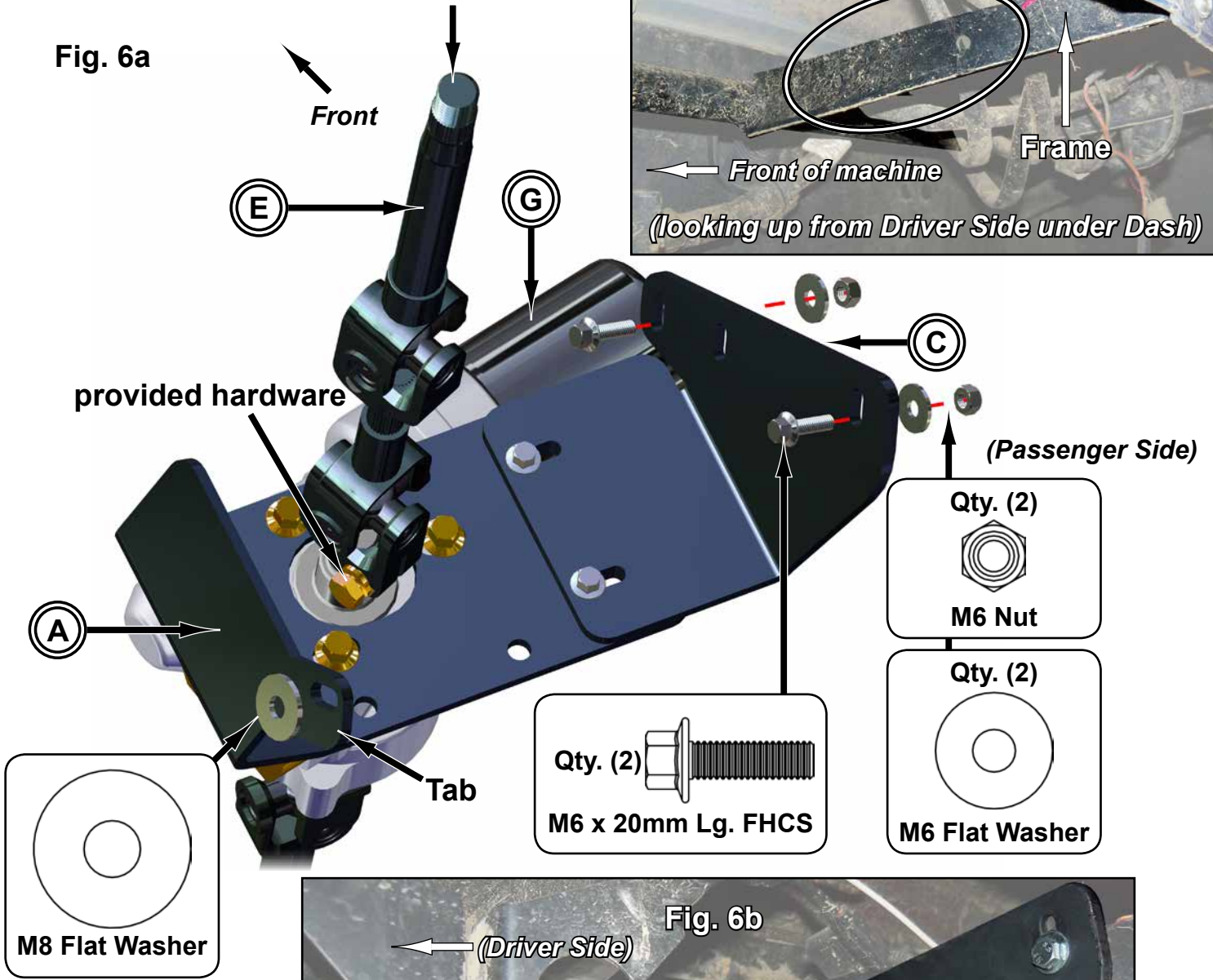
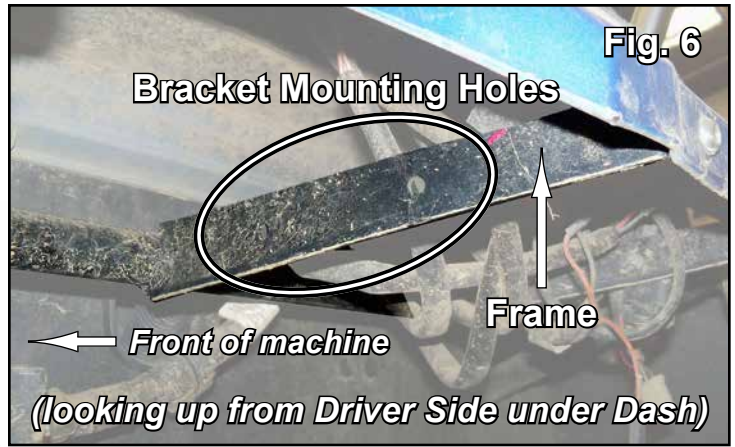
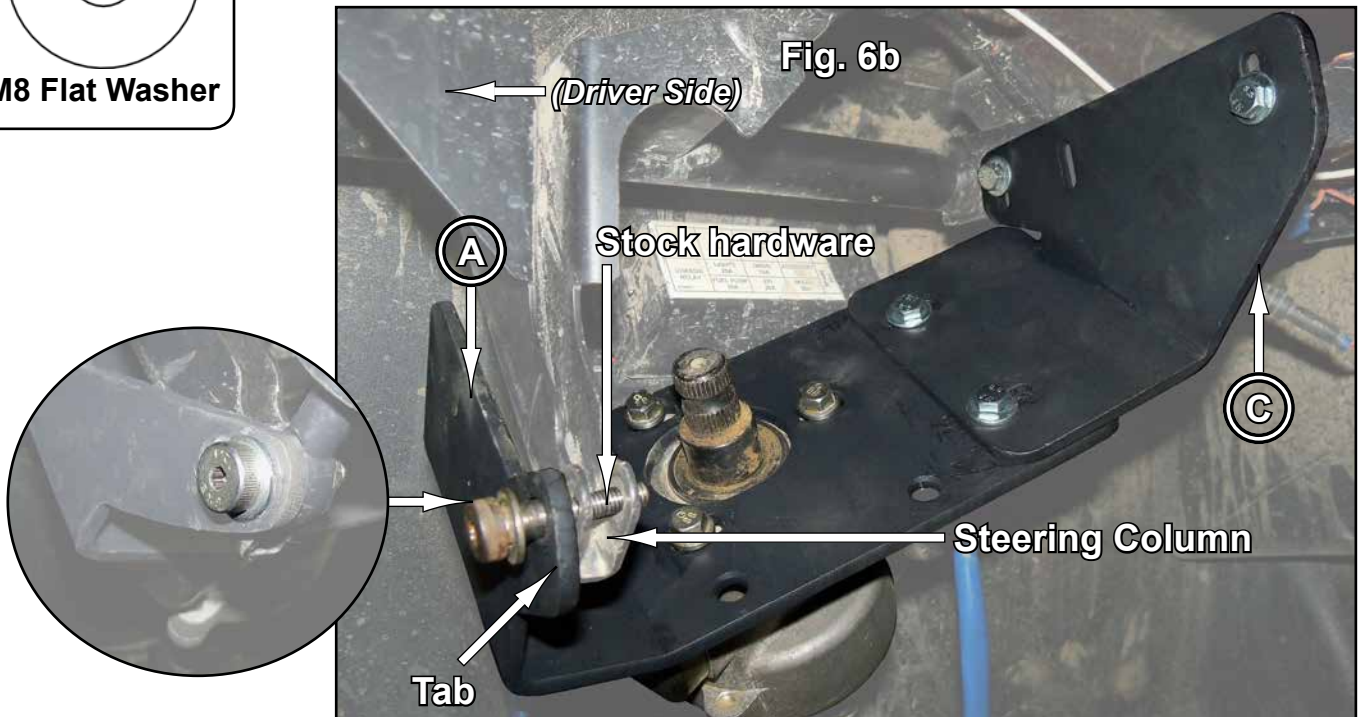
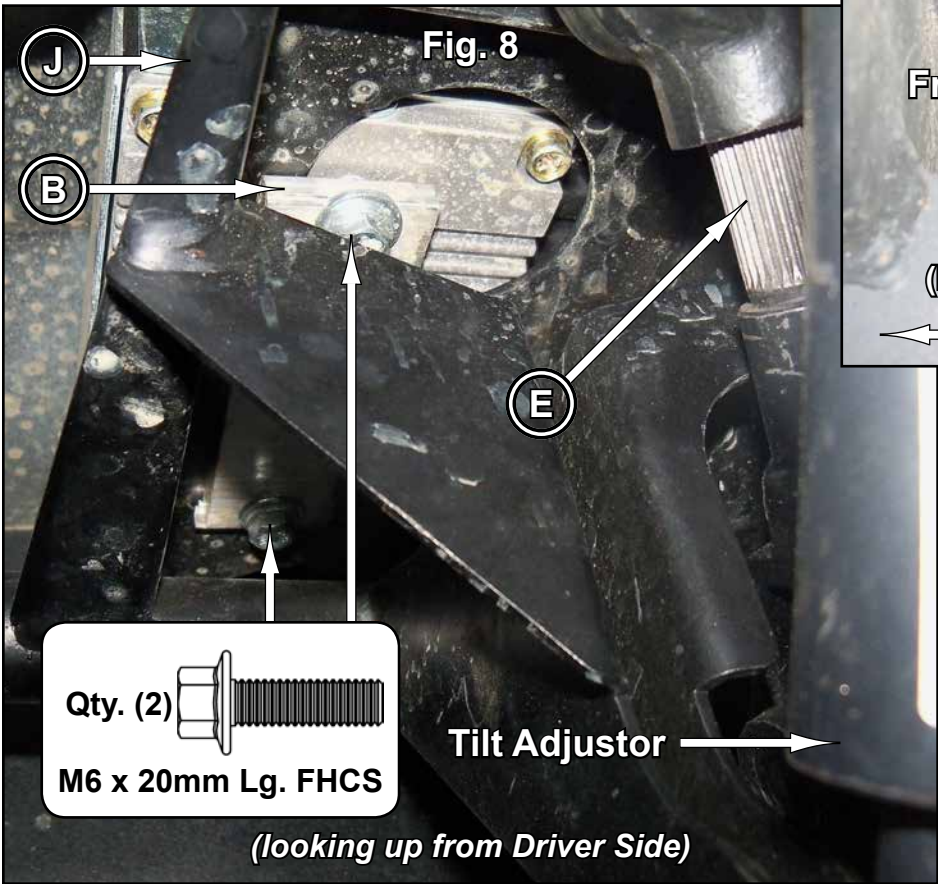
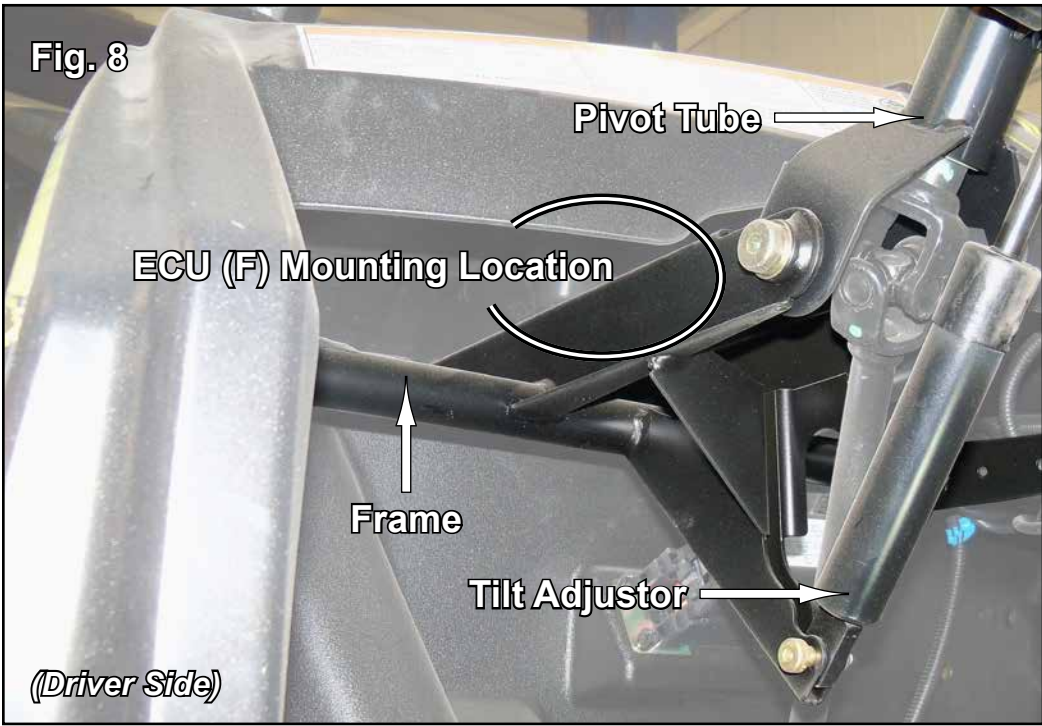

Fig. 6b





Connections

- Before installing, ensure that all waterproof connections are properly seated.
- If Gaskets are not seated, as shown, use a Flathead Screwdriver to seat.

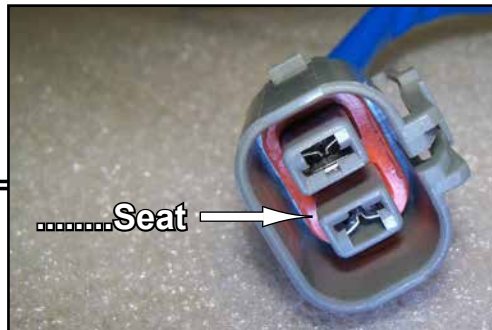
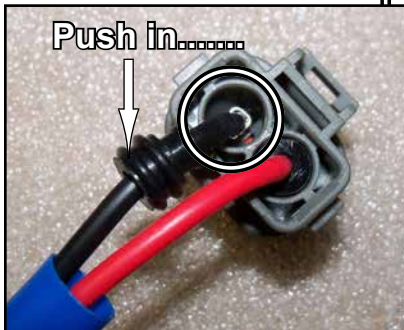
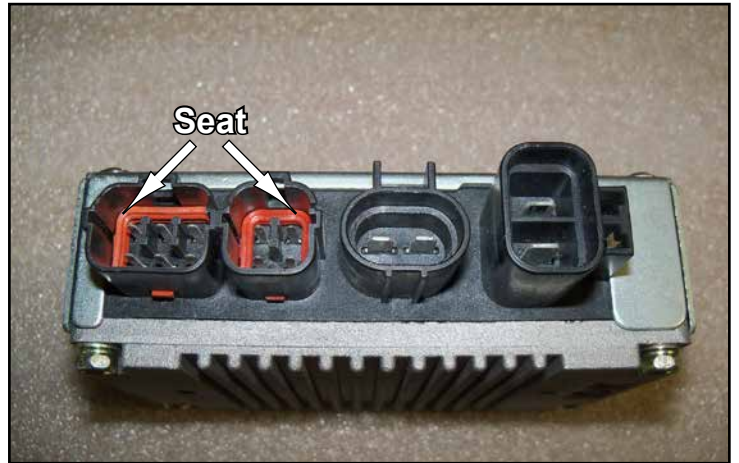
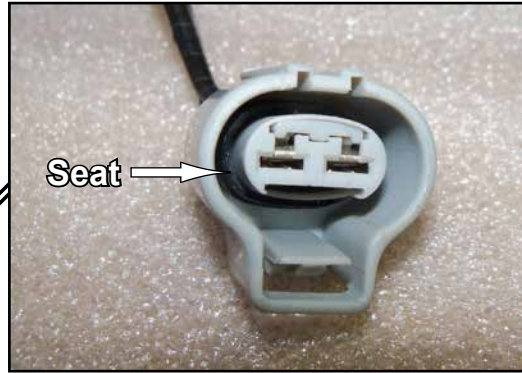

Wiring Details

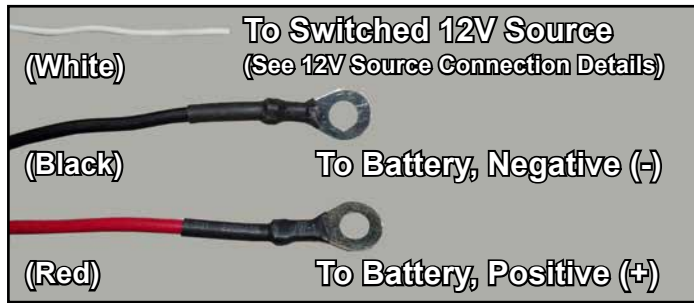

Switched 12V Source Connection Details

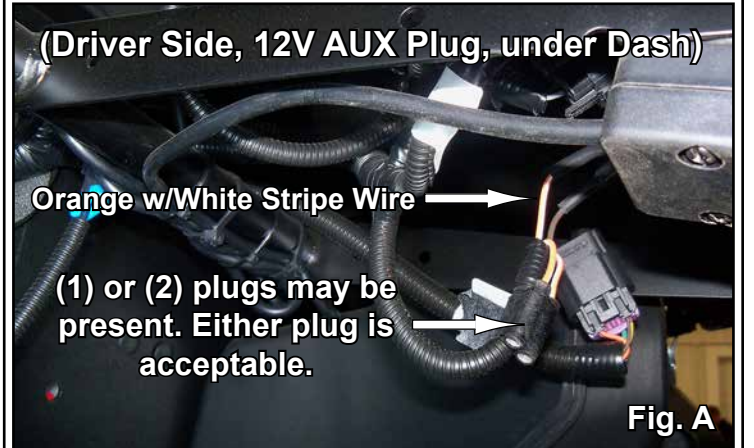

1. Locate Orange with White Stripe wire underneath dash. See Fig. A.
2. Determine connector style to use. See Fig. B - C. SuperATV recommends use of Bullet Connector.
3. Make connection. See Fig.A.

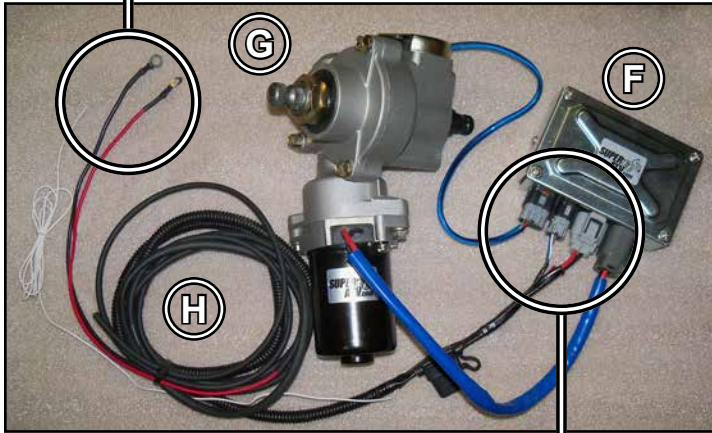

Plug	Function
A	Torque Sensor
B	Switched 12V Source
C	Power
D	Motor

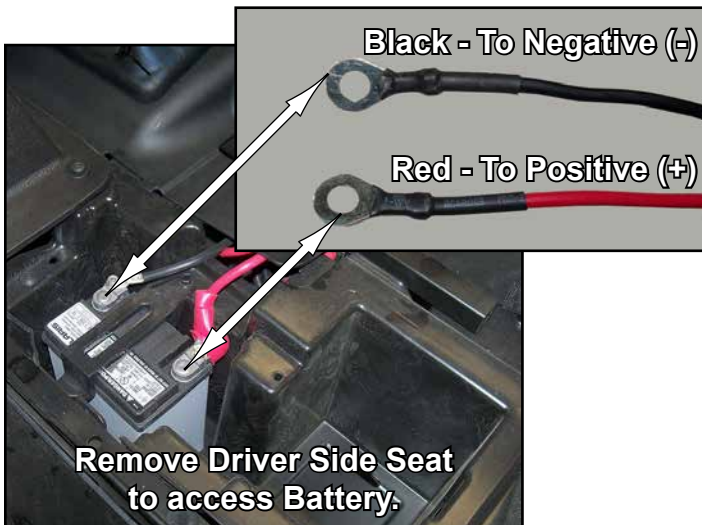
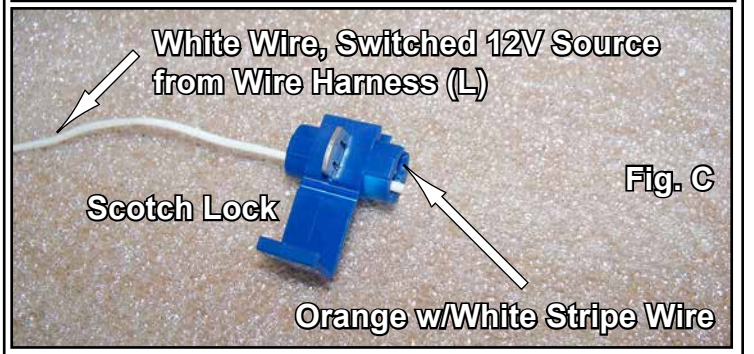
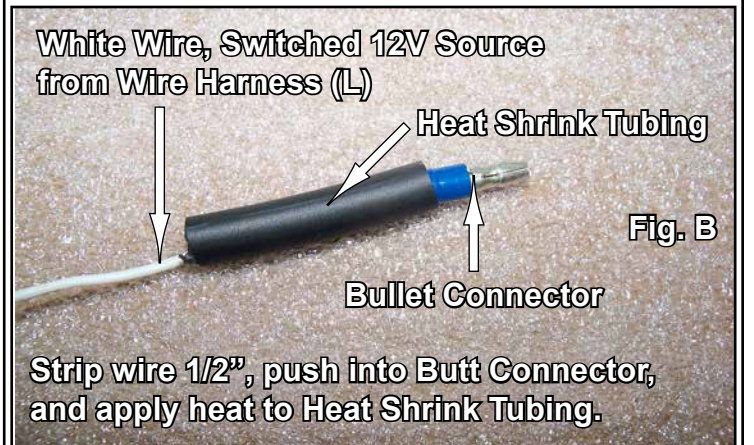

When activated, Diagnostic Light will flash (1) time for about (1) second before turning off indicating proper function. Should different patterns occur, contact SuperATV.

Secure Diagnostic Light in a visible location.

